

Only layout change, no design change of the product.
Prior drawing No. AC-6651xx/ Rev 02/ May 18, 2005

"All dimensions in mm"

Customer drawing subject to change without notice!

Prior Issue	Drawn	Approved	Released	CONFIDENTIAL: Information contained in this document or drawing is confidential and proprietary to Greiner Bio-One GmbH. This document may not be reproduced for any reason without written permission from Greiner Bio-One GmbH. All rights of design, invention, and copyright are reserved.
Revision	Date 2011/04/19	Date 2011/04/19	Date 2011/04/19	
Date	Name falter	Name falter	Name sonntag	

Valid for Item-No.: 665102, 665180

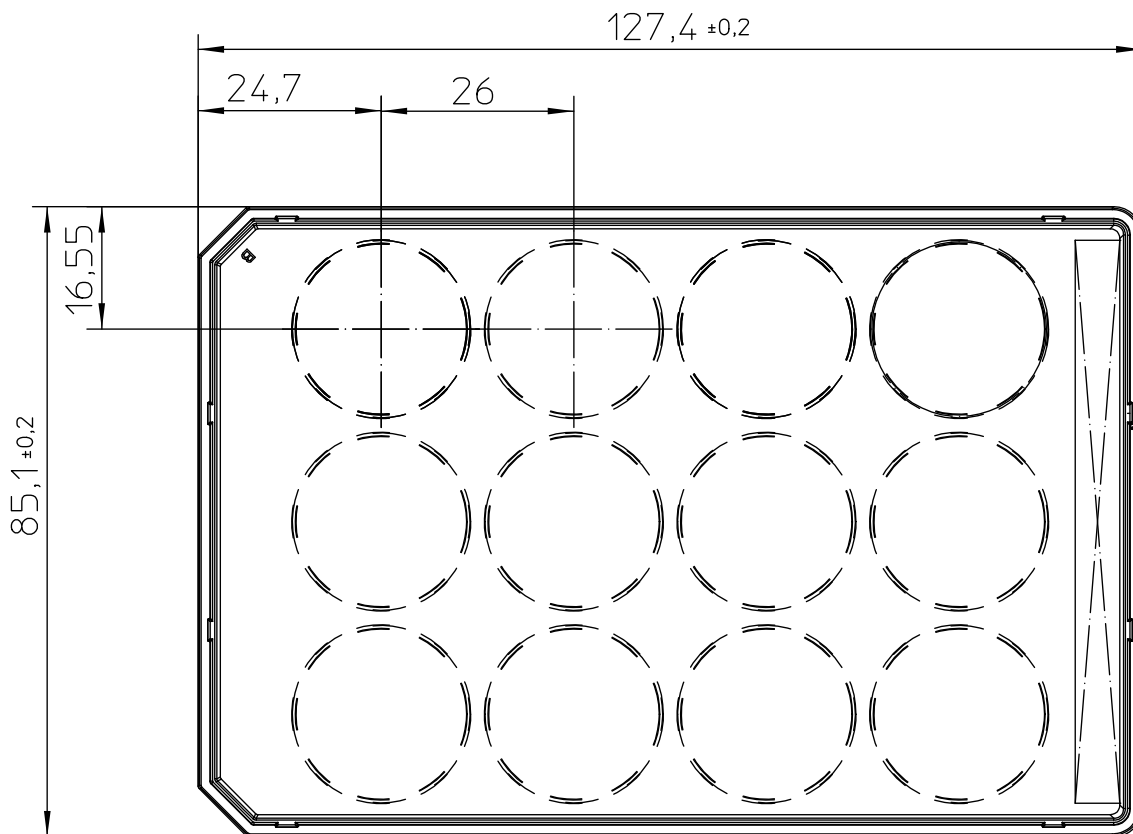
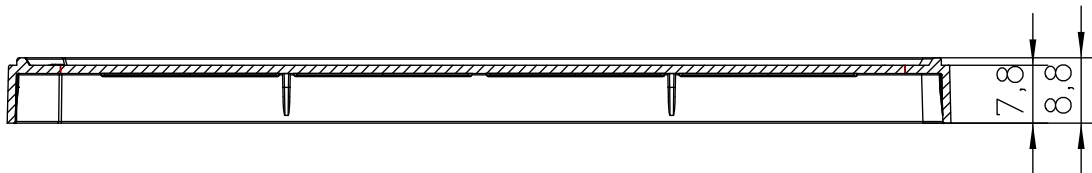

"All dimensions in mm"

Customer drawing subject to change without notice!

Prior Issue	Drawn	Approved	Released	CONFIDENTIAL: Information contained in this document or drawing is confidential and proprietary to Greiner Bio-One GmbH. This document may not be reproduced for any reason without written permission from Greiner Bio-One GmbH. All rights of design, invention, and copyright are reserved.
Revision	Date 2011/04/19	Date 2011/04/19	Date 2011/04/19	
Date	Name falter	Name falter	Name sonntag	